









ZNÁŠ TYTO TECHNICKE PROSTREDKY



	grafický znak	název
		sací koš,
		hadice
		plnoprúdová proudnice
		ruční stříkačka
		savice

	grafický znak	název
		sběrač
		rozdělovač,
		požární stříkačka

JAKÉ JEDNODUCHÉ HASEBNÍ PROSTŘEDKY PATŘÍ DO POŽÁRNÍHO PŘÍSTŘEŠKU?

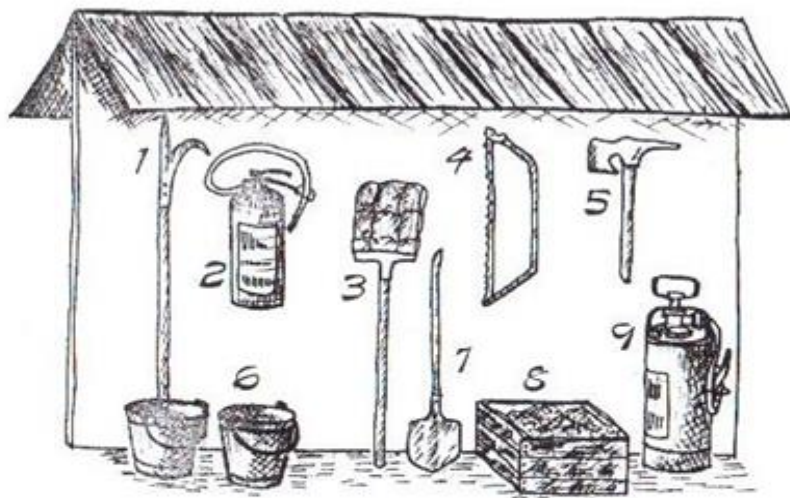

DOPLŇ JEJICH NÁZVY:

① HÁK	⑥ KBELÍK
② HASICÍ PŘÍSTROJ	⑦ LOPATA
③ TLUMICE	⑧ BEDNA S PÍSKEM
④ PILA	⑨ DŽBEROVÁ STŘÍKAČKA
⑤ SEKERA	

Doplň telefonní číslo:



Hasiči

150



Záchranná služba

155



Policie

158

SLEDUJ 1 MINUTU TYTO PŘEDMĚTY A PAK ZKUS NAPSAT, CO SIS ZAPAMATOVAL

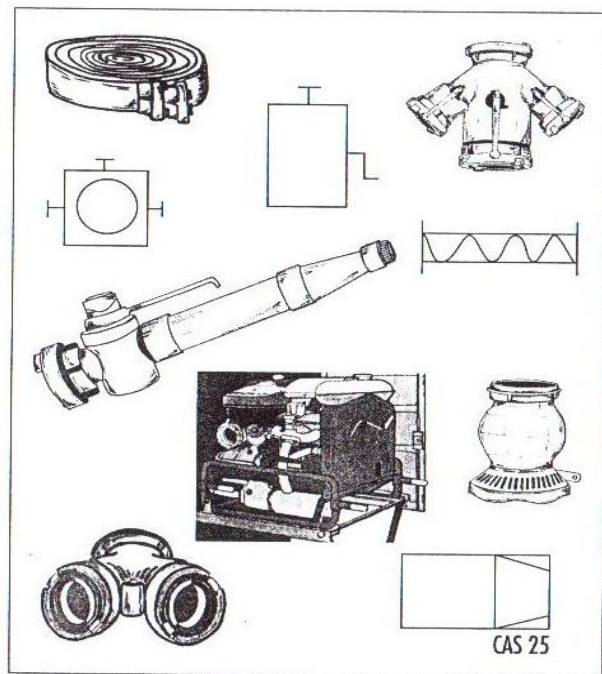

CAS 25

Pamatuješ si, které z nich byly na obrázku a které byly zobrazeny grafickým znakem?

KOLIK OBJEVÍŠ NA OBRÁZKU POŽÁRNÍCH ZÁVAD?

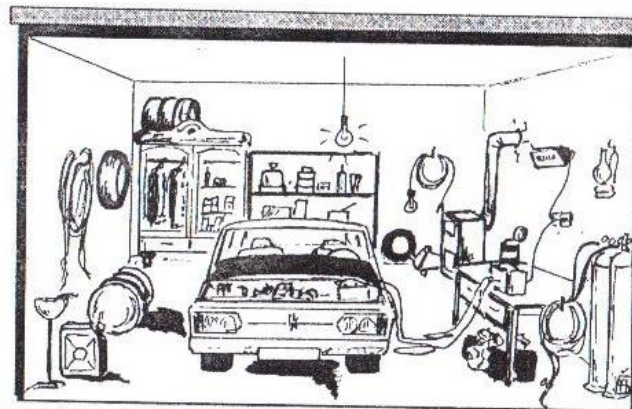

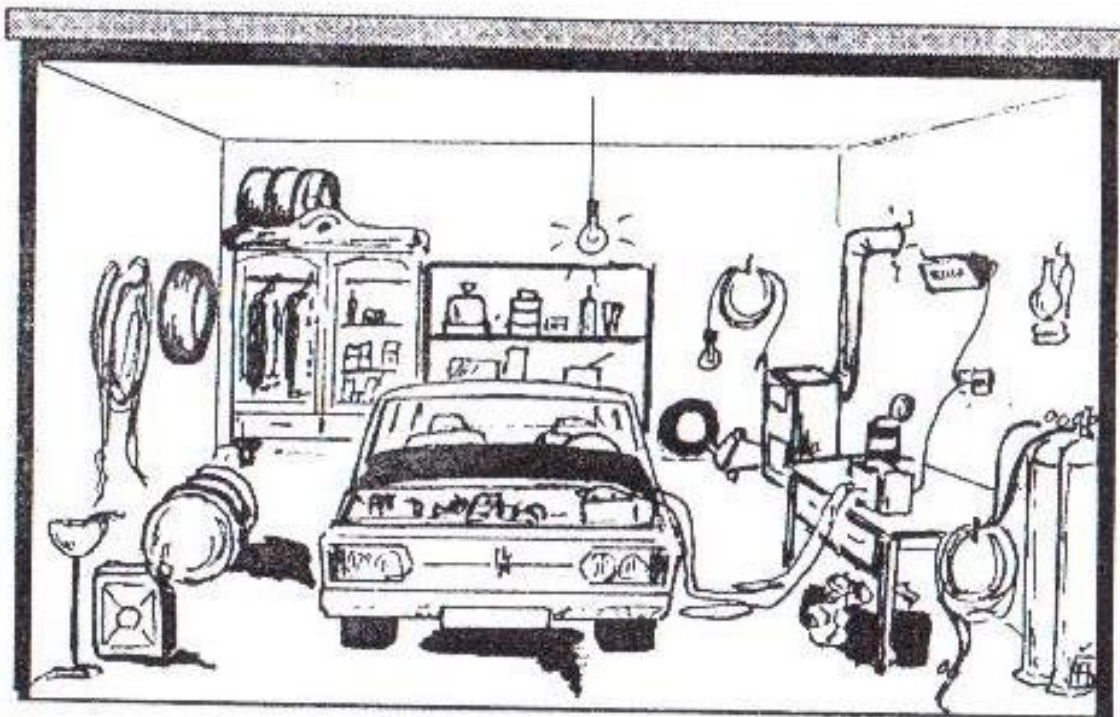

- 1) olejová skvrna pod vozidlem
- 2) mnoho hořlavých kapalin
- 3) otevřené nádoby s hořlavou kapalinou
- 4) zapnutý infrazářič bez dozoru
- 5) svítidlo bez ochranného krytu
- 6) tlakové láhve nejsou zajištěny proti pádu
- 7) mastné hadry pod stolem
- 8) mnoho hořlavého materiálu



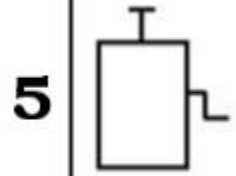
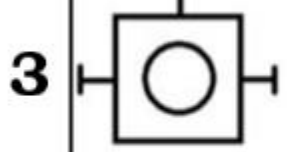

Spoj hasičskou značku s vybavením.

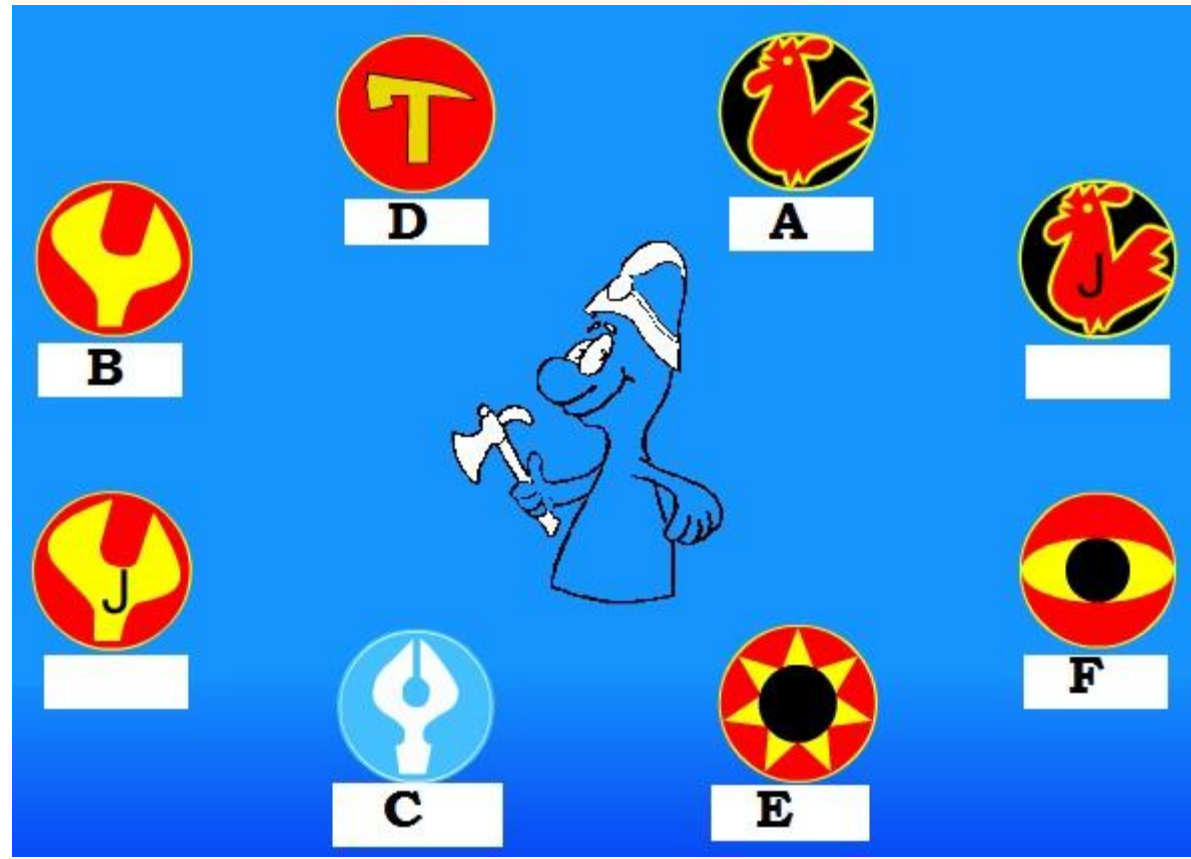

1)	d
2)	g
3)	a
4)	c
5)	f
6)	b
7)	e



POJMENUJ ODBORKU	
A	PREVENTISTA
B	STROJNÍK
C	KRONIKÁŘ
D	VELITEL
E	CVIČITEL
F	INSTRUKTOR

	Skupiny hořlavých látek:	vhodné	nevhodné
	motorová vozidla, tuky, mazadla, asfalt, dehet	práškový	vodní
	dřevo, hobliny, piliny, sláma, papír, pevné organické látky, líh	vodní	CO ₂ sněhový
	archívy, knihovny, svazky papíru, alkohol, hořlavé kovy a jejich slitiny, textilie	práškový	vodní pěnový
	benzín, nafta, olej, laky, barvy, pryž	pěnový práškový	vodní CO ₂ - sněhový
	elektrická zařízení pod napětím, potraviny, telefonní ústředny, jemná mechanika, počítače, videa	CO ₂ sněhový	vodní pěnový

TROCHU HASIČINY ☺

1) POJMENUJ

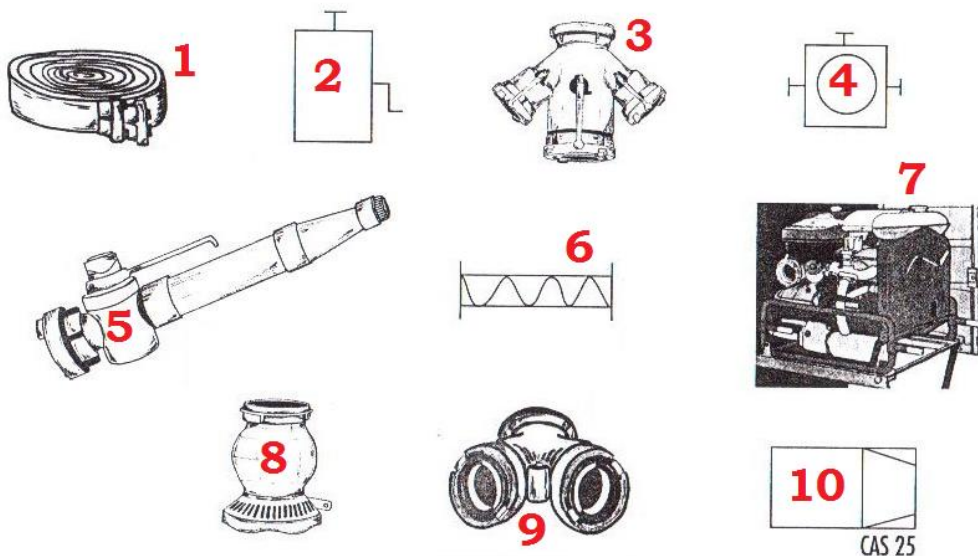

1)	HADICE V KOTOUČI
2)	DŽBEROVÁ STŘÍKAČKA
3)	ROZDĚLOVAČ
4)	PŘETLAKOVÝ VENTIL
5)	PROUDNICE
6)	SAVICE
7)	POŽÁRNÍ STŘÍKAČKA
8)	SACÍ KOŠ
9)	SBĚRAČ
10)	POŽÁRNÍ AUTOMOBIL

2) Doplň název:

1)		EJEKTOR LEŽATÝ
2)		SBĚRAČ
3)		PŘETLAKOVÝ VENTIL
4)		PŘIMĚŠOVAČ

5)		RUČNÍ STŘÍKAČKA
6)		HÁKOVÝ ŽEBŘÍK
7)		HADICOVÝ MŮSTEK
8)		SACÍ KOŠ

3) Doplň název:

NEBEZPEČÍ	POZOR	VODU (VPŘED)	ROZUMÍM	POMALEJI	STÁT, VODU STAV

